

## Surface Mount General Purpose Rectifier

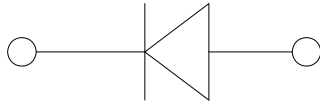
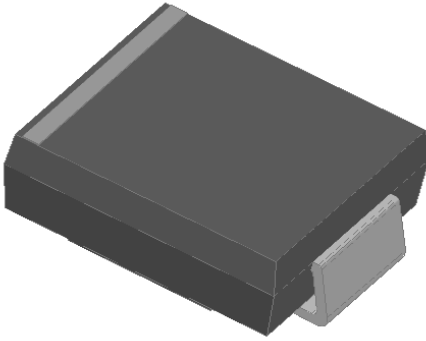

### Features

- Low profile package
- Ideal for automated placement
- Glass passivated chip junction
- High forward surge capability
- Meets MSL level 1, per J-STD-020, LF maximum peak of 260 °C

### Typical Applications

For use in general purpose rectification of power supplies, inverters, converters, and freewheeling diodes for consumer, and telecommunication.

### Mechanical Data

- Package: DO-214AB (SMC)
- Molding compound meets UL 94 V-0 flammability rating, RoHS-compliant, halogen-free
- Terminals: Tin plated leads, solderable per J-STD-002 and JESD22-B102
- Polarity: Color band denotes the cathode end

### ■ Maximum Ratings (T<sub>a</sub>=25°C Unless otherwise specified)

PARAMETER	SYMBOL	UNIT	GS8A	GS8B	GS8D	GS8G	GS8J	GS8K	GS8M
Device marking code			GS8A	GS8B	GS8D	GS8G	GS8J	GS8K	GS8M
Maximum Repetitive peak reverse voltage	V <sub>RRM</sub>	V	50	100	200	400	600	800	1000
Maximum RMS Voltage	V <sub>RMS</sub>	V	35	70	140	280	420	560	700
Maximum DC Blocking Voltage	V <sub>DC</sub>	V	50	100	200	400	600	800	1000
Average Rectified Output Current @60Hz sine wave, Resistance load, TL (FIG.1)	I <sub>o</sub>	A	8.0						
Forward Surge Current (Non-repetitive) @60Hz Half-sine wave, 1 cycle, T <sub>j</sub> =25°C	I <sub>FSM</sub>	A	200						
Forward Surge Current (Non-repetitive) @1ms, square wave, 1 cycle, T <sub>j</sub> =25°C			400						
Current squared time @1ms≤t≤8.3ms T <sub>j</sub> =25°C	I <sup>2</sup> t	A <sup>2</sup> s	166						
Storage Temperature	T <sub>stg</sub>	°C	-55 ~ +150						
Junction Temperature	T <sub>j</sub>	°C	-55 ~ +150						



# GS8A THRU GS8M

## ■ Electrical Characteristics (T<sub>a</sub>=25°C Unless otherwise specified)

PARAMETER	SYMBOL	UNIT	TEST CONDITIONS	GS8A	GS8B	GS8D	GS8G	GS8J	GS8K	GS8M
Maximum instantaneous forward voltage	V <sub>F</sub>	V	I <sub>FM</sub> =8.0A	1.1						
Maximum DC reverse current at rated DC blocking voltage	I <sub>R</sub>	μA	T <sub>j</sub> =25°C	5						
			T <sub>j</sub> =125°C	100						
Typical junction capacitance	C <sub>j</sub>	pF	Measured at 1MHz and Applied Reverse Voltage of 4.0 V.D.C	55						

## ■ Thermal Characteristics (T<sub>a</sub>=25°C Unless otherwise specified)

PARAMETER	SYMBOL	UNIT	GS8A	GS8B	GS8D	GS8G	GS8J	GS8K	GS8M
Typical Thermal resistance	R <sub>θJ-A</sub> (1)	°C/W	50						
	R <sub>θJ-L</sub> (1)		18						
	R <sub>θJ-C</sub> (1)		15						

Note(1)

Thermal resistance from junction to ambient and from junction to lead mounted on P.C.B. with 0.6" x 0.6" (16 mm x 16 mm) copper pad areas

## ■ Ordering Information (Example)

PREFERRED P/N	PACKAGE CODE	UNIT WEIGHT(g)	MINIMUM PACKAGE(pcs)	INNER BOX QUANTITY(pcs)	OUTER CARTON QUANTITY(pcs)	DELIVERY MODE
GS8A~GS8M	F1	Approximate 0.261	3000	/	42000	13" reel

## ■ Characteristics(Typical)

FIG.1: I<sub>o</sub>-T<sub>L</sub> Curve

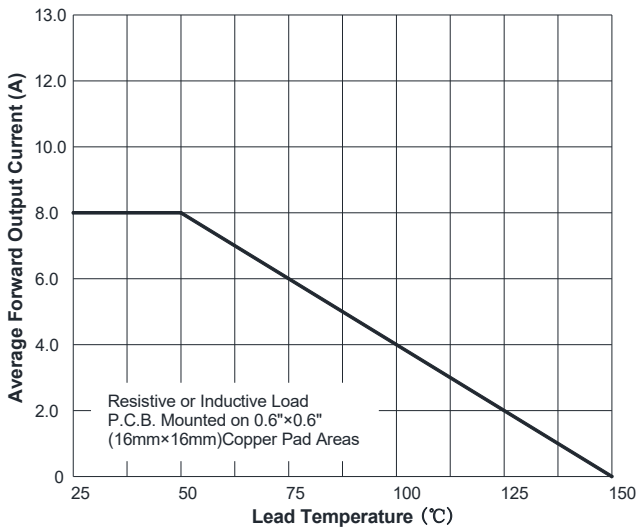
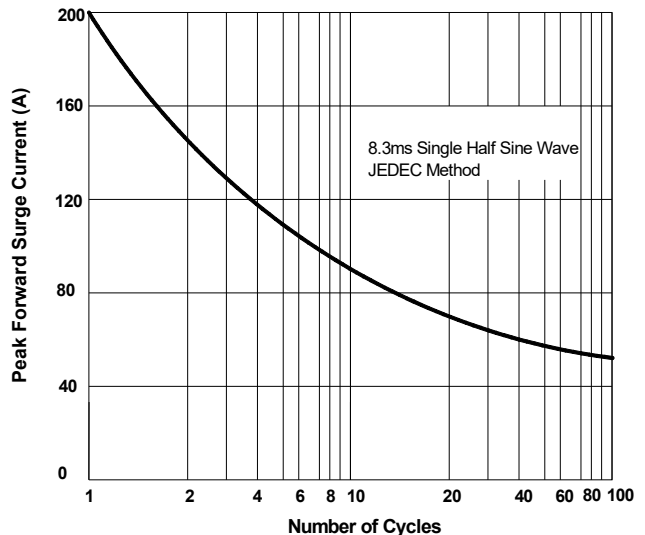

FIG.2: Forward Surge Current Capability





# GS8A THRU GS8M

FIG.3: Typical Forward Voltage

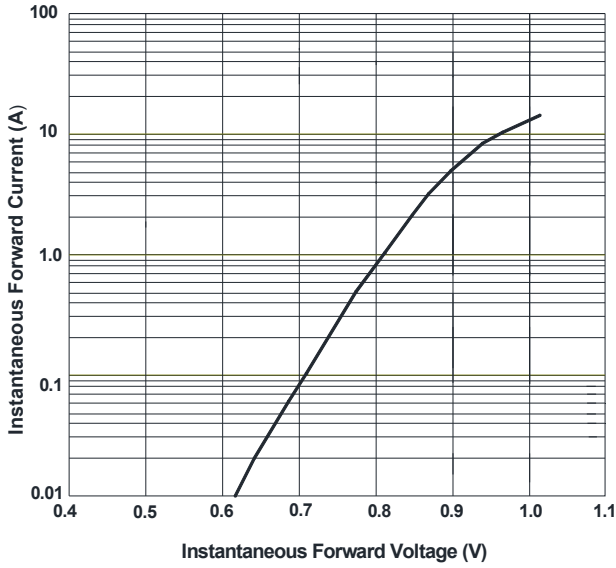
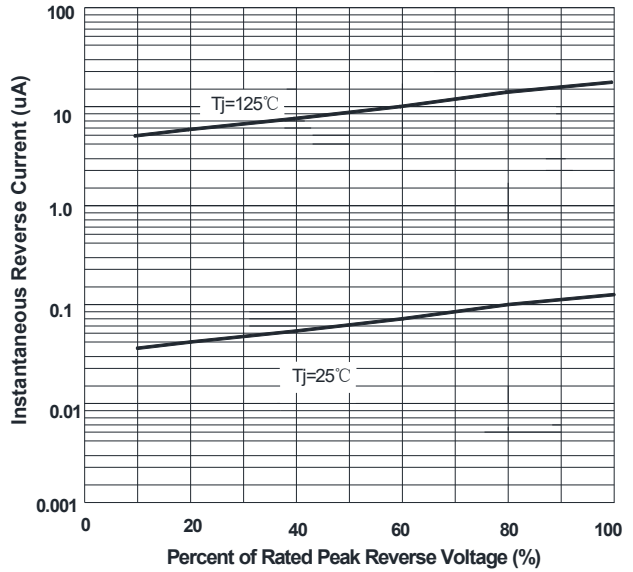
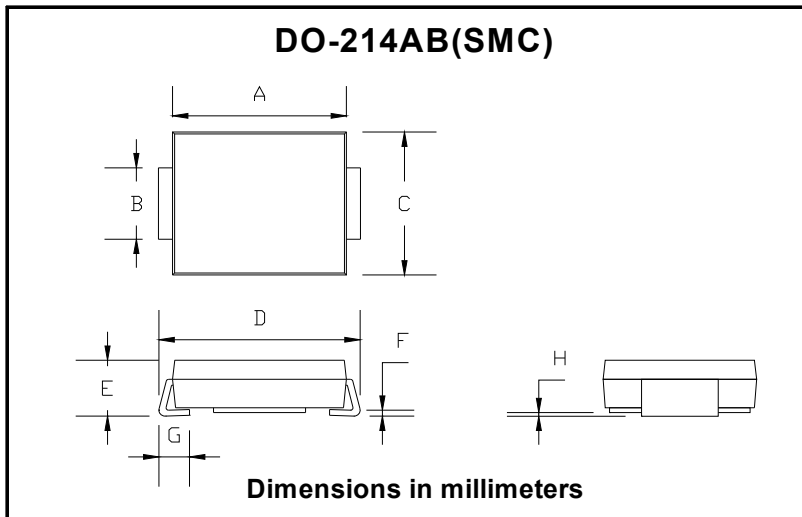

FIG.4: Typical Reverse Characteristics



## ■ Outline Dimensions



DO-214AB (SMC)		
Dim	Min	Max
A	6.60	7.11
B	2.85	3.27
C	5.59	6.22
D	7.75	8.13
E	1.99	2.61
F	0.15	0.31
G	0.76	1.52
H	0.05	0.20

## ■ Suggested pad layout

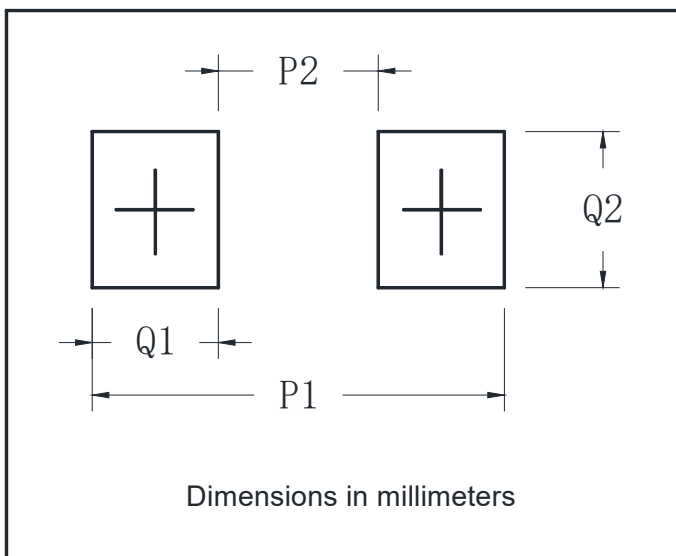

DO-214AB (SMC)	
Dim	Min
P1	9.9
P2	3.84
Q1	3.03
Q2	3.82



## GS8A THRU GS8M

---

### Disclaimer

The information presented in this document is for reference only. Yangzhou Yangjie Electronic Technology Co., Ltd. reserves the right to make changes without notice for the specification of the products displayed herein to improve reliability, function or design or otherwise.

The product listed herein is designed to be used with ordinary electronic equipment or devices, and not designed to be used with equipment or devices which require high level of reliability and the malfunction of which would directly endanger human life (such as medical instruments, transportation equipment, aerospace machinery, nuclear-reactor controllers, fuel controllers and other safety devices), Yangjie or anyone on its behalf, assumes no responsibility or liability for any damages resulting from such improper use of sale.

This publication supersedes & replaces all information previously supplied. For additional information, please visit our website [http:// www.21yangjie.com](http://www.21yangjie.com) , or consult your nearest Yangjie's sales office for further assistance.